

# NATIONAL INDUSTRIES

16442

SEC. NO:-16442

IND-27

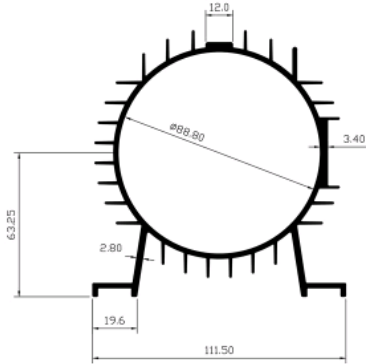

WEIGHT:- 12.500 kg/12'

MOTORBODY

16443

SEC. NO:-16443

IND-26

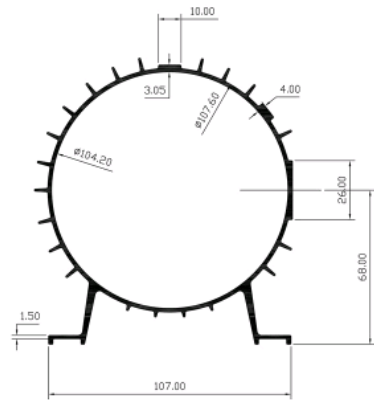

WEIGHT:- 9.400 kg/12'

MOTORBODY

16444

SEC. NO:-16444

38016 (NIKOO)

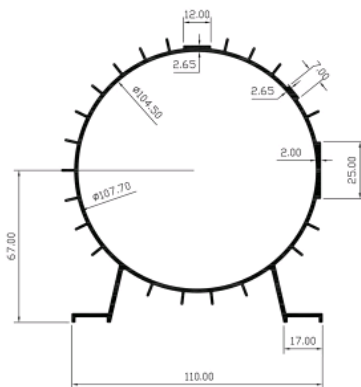

WEIGHT:- 8.300 kg/12'

MOTORBODY

16445

SEC. NO:-16445

IND-63 (25119)

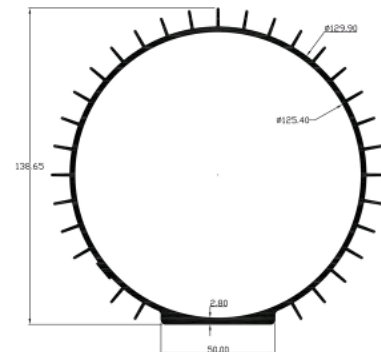

WEIGHT:- 12.724 kg/12'

MOTORBODY

# NATIONAL INDUSTRIES

16446

SEC. NO:-16446

IND-61 (25114)

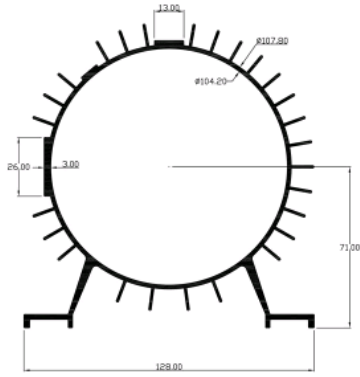

WEIGHT:- 12.607 kg/12'

MOTORBODY

16447

SEC. NO:-16447

IND-67 (25120)

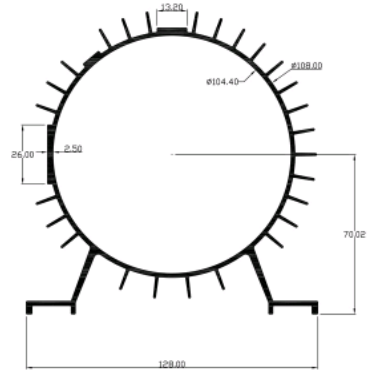

WEIGHT:- 11.653 kg/12'

MOTORBODY

16448

SEC. NO:-16448

IND-62 (25123)

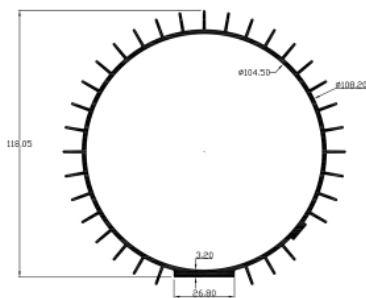

WEIGHT:- 9.675 kg/12'

MOTORBODY

16449

SEC. NO:-16449

IND-64 (25116)

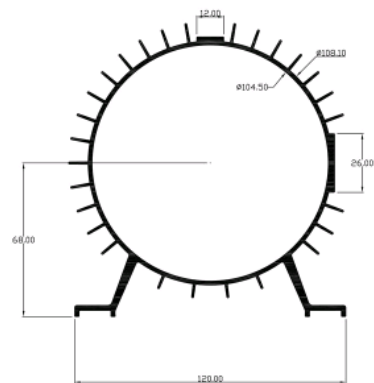

WEIGHT:- 11.653 kg/12'

MOTORBODY

# NATIONAL INDUSTRIES

16450

SEC. NO:-16450

IND-66 (25121)

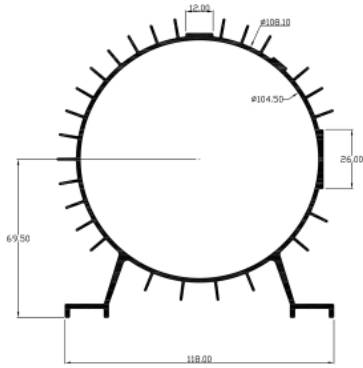

WEIGHT:- 10.847 kg/12'

MOTORBODY

16451

SEC. NO:-16451

IND-69 (25126)

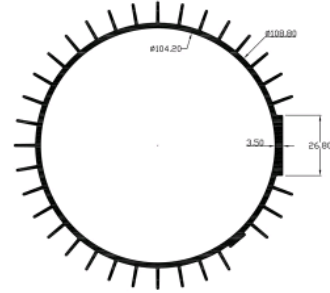

WEIGHT:- 11.750 kg/12'

MOTORBODY

16452

SEC. NO:-16452

IND-69 (25117)

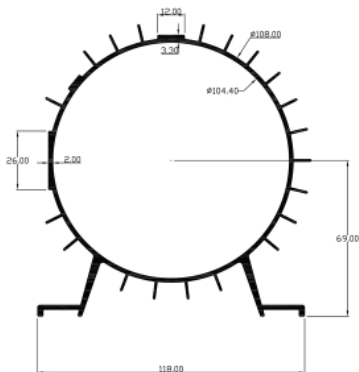

WEIGHT:- 10.418 kg/12'

MOTORBODY

16645

SEC. NO:-16645

IND-146 (38010)

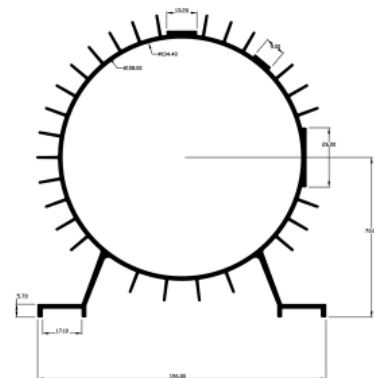

WEIGHT:- 11.400 kg/12'

MOTORBODY

# NATIONAL INDUSTRIES

16726

SEC. NO.-16726

IND-86 (25115)

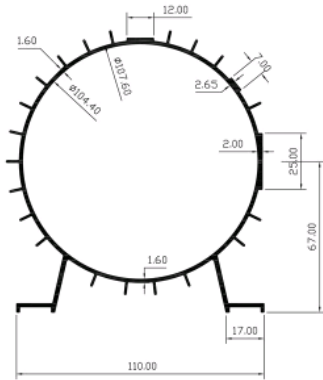

WEIGHT:- 8.370 kg/12'

MOTORBODY

16727

SEC. NO.-16727

PE-166

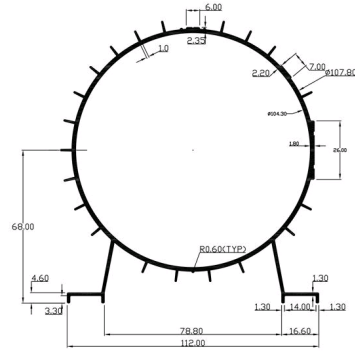

WEIGHT:- 8.125 kg/12'

MOTORBODY